



AL1024ULX Series Power Supply/Charger Installation Guide

Models Include:

- ***AL1024ULX***
 - *Single Output*

- ***AL1024ULXPD4***
 - *Four (4) Fused Outputs*

- ***AL1024ULXPD8***
 - *Eight (8) Fused Outputs*

- ***AL1024ULXPD16***
 - *Sixteen (16) Fused Outputs*

- ***AL1024ULXPD4CB***
 - *Four (4) PTC Outputs*

- ***AL1024ULXPD8CB***
 - *Eight (8) PTC Outputs*

- ***AL1024ULXPD16CB***
 - *Sixteen (16) PTC Outputs*

















For a red enclosure, add an "R" suffix to the part # e.g. AL1024ULXPD8R

Overview:

The AL1024ULX is a power supply that converts a 115VAC / 60Hz input, to a 24VDC regulating output (see specifications below).

The AL1024ULX is the base power supply unit for the UL Listed multi-output power supply/charger series: AL1024ULXPD4, AL1024ULXPD4CB, AL1024ULXPD8, AL1024ULXPD8CB, AL1024ULXPD16, AL1024ULXPD16CB (Refer to AL1024ULX Series Power Supply Configuration Reference Chart below).

AL1024ULX Series Power Supply Configuration Reference Chart:

Altronix Model Number	Accessory Power Distribution Module(s)	Number of Outputs	Class 2 Rated Power Fused Outputs	PTC Outputs	Output Rating (amp) per Output	Agency Listings	UL Listings and File Numbers	
AL1024ULX(R)	-	1	-	-	10	   	UL File # S4707 UL 1481 UL Listed Power Supply for Fire Protective Signaling Systems <hr/> UL 294 UL Listed Access Control System Unit. <hr/> "Signal Equipment" Evaluated to CSA 22.2 N205-M1983	
AL1024ULXPD4	PD4UL	4	-	x	3.5	 		
AL1024ULXPD4CB	PD4ULCB	4	x	-	x	2.5		 
AL1024ULXPD8	PD8UL	8	-	x	-	3.5		 
AL1024ULXPD8CB	PD8ULCB	8	x	-	x	2.5		 
AL1024ULXPD16	Two (2) PD8UL	16	-	x	-	3.5		 
AL1024ULXPD16CB	Two (2) PD8ULCB	16	x	-	x	2.5		 

Do not exceed total output rating of 10 amp per unit.

Specifications:

Input:

- Input 115VAC / 60Hz, 4.4 amp.

Output:

- 24VDC output.
- 10 amp total supply current at 24VDC.
- Filtered and electronically regulated outputs.
- Short circuit and thermal overload protection.

Battery Backup:

- Built-in charger for sealed lead acid or gel type batteries.
- Automatic switch over to stand-by battery when AC fails.
- Maximum charge current 3.6 amp.

Battery Backup (cont'd):

- Zero voltage drop when switched over to battery backup.

Supervision:

- AC fail supervision (form "C" contacts).
- Low battery supervision (form "C" contacts).
- Battery presence supervision (form "C" contacts).

Additional Features:

- AC input and DC output LED indicators.
- Power supply, enclosure, cam lock and battery leads
- All models are available in red enclosure (add an "R" suffix to the part # e.g. AL1024ULXPD8R).

Stand-by Specifications (total current shown):

Output	15 Min. of Stand-by & 5 Mins. of Alarm	4 hr. of Stand-by & 5 Mins. of Alarm	24 hr. of Stand-by & 5 Mins. of Alarm	60 hr. of Stand-by & 5 Mins. of Alarm
24VDC / 12AH Battery	Stand-by = 8 amp Alarm = 10 amp	Stand-by = 1.5 amp Alarm = 10 amp	Stand-by = 200mA Alarm = 10 amp	Stand-by = 100mA Alarm = 10 amp

Output	15 Min. of Stand-by & 15 Mins. of Alarm	4 hr. of Stand-by & 5 Mins. of Alarm	24 hr. of Stand-by & 15 Mins. of Alarm	60 hr. of Stand-by & 15 Mins. of Alarm
24VDC / 65AH Battery		Stand-by = 8.0 amp Alarm = 10 amp	Stand-by = 1.5 amp Alarm = 10 amp	Stand-by = 500mA Alarm = 10 amp

See battery size calculation worksheet for other batteries (Page 7).

Installation Instructions:

The unit should be installed in accordance with article 760 of The National Electrical Code as well as NFPA 72 and all applicable Local Codes.

1. Mount the unit in desired location.

Fig. 1

CAUTION: De-energize unit prior to servicing. For continued protection against risk of electric shock and fire hazard replace fuses with the same type and rating: Input fuse 10A, 250V, Battery fuse 15A, 32V. Replace fuse cover before energizing. Do not expose to rain or moisture.

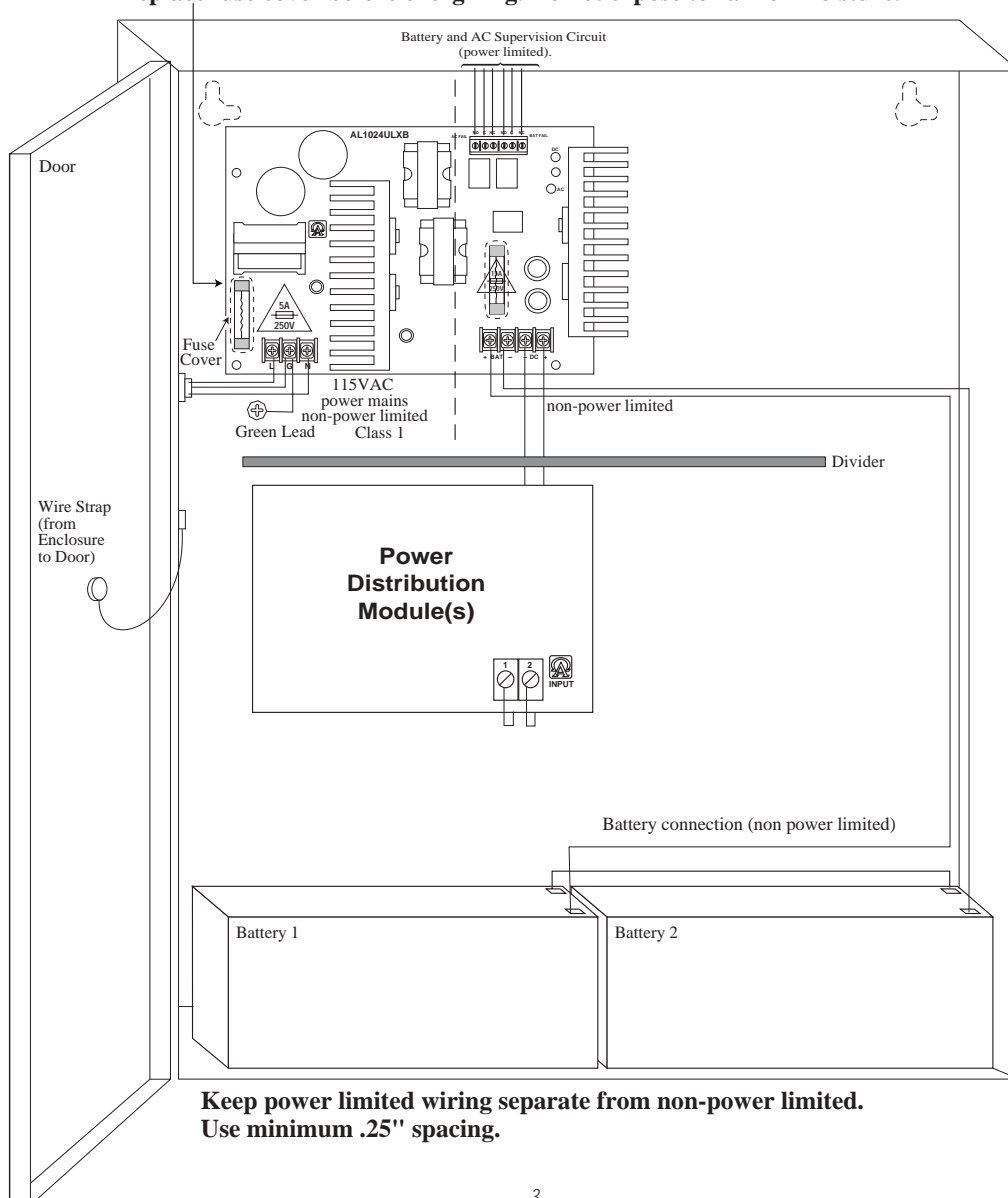

Keep power limited wiring separate from non-power limited. Use minimum .25" spacing.

2. Secure enclosure to earth ground. Connect AC power (115VAC / 60 Hz to terminals marked [L, G, N] (*Fig. 1, pg. 3*). Use 14 AWG or larger for all power connections (Battery, DC output, AC input). Use 22 AWG to 18 AWG for power limited circuits (AC Fail/Low Battery reporting). Keep power limited wiring separate from non-power limited wiring (115VAC / 60Hz Input, Battery Wires). Minimum .25" spacing must be provided.
3. Measure output voltage before connecting device. This helps avoid potential damage.
When servicing the unit, AC mains should be removed.
4. Connect devices to be powered:
 - a. For AL1024ULX Power Supply connect devices to terminals marked [+ DC -] (*Fig. 1, pg. 3*)
 - b. For other Power Distribution Models connect devices to be powered to terminal pairs 1 to 4 marked [1P & 1N thru 4P & 4N] (*Fig. 2A & 2B, pg. 5*) or 1 to 8 marked [1P & 1N thru 8P & 8N] (*Fig. 3A & 3B, pg. 5*) carefully observing correct polarity.
5. For Access Control applications, batteries are optional. When batteries are not used a loss of AC will result in the loss of output voltage. When the use of stand-by batteries is desired, they must be lead acid or gel type.
6. Connect appropriate signaling notification devices to terminals marked [AC FAIL & BAT FAIL] (*Fig. 1, pg. 3*) supervisory relay outputs.
Note: When used in fire alarm, burglar alarm or access control applications, "AC Fail" relay must be used to provide a visual indication of AC power on.
7. Please insure that the cover is secured with the provided Key Lock.

LED Diagnostics:

AL1024ULXB - Power Supply Board

Red (DC)	Green (AC)	Power Supply Status
ON	ON	Normal operating condition
ON	OFF	Loss of AC, Stand-by battery supplying power
OFF	ON	No DC output
OFF	OFF	Loss of AC. Discharged or no stand-by battery. No DC output.

Terminal Identification:

AL1024ULXB - Power Supply Board

Terminal Legend	Function/Description
L, G, N	Connect 115VAC to these terminals: L to Hot, N to Neutral, G to ground.
- DC +	24VDC @ 8 amp continuous, 10 amp in alarm non-power limited output, 10 amp continuous when batteries are not used.
AC FAIL N.O., C, N.C.	Used to notify loss of AC power, e.g. connect to annunciator/alarm panel. Relay normally energized when AC power is present. Contact rating 1 amp @ 28VDC. AC or brownout fail is reported within 1 minute of event. To delay reporting of up to 6 hrs., cut "AC delay" jumper and reset power to unit.
BAT FAIL N.O., C, N.C.	Used to indicate low battery condition, e.g. connect to alarm panel. Relay normally energized when DC power is present. Contact rating 1 amp @ 28VDC. A removed battery is reported within 1 minute. Battery reconnection is reported within 1 minute. Low battery threshold: @ approximately 21VDC.
+ BAT -	Stand-by battery connections. Maximum charge rate 3.6 amp.

LED Diagnostics:
PD4UL/PD4ULCB/PD8UL/PD8ULCB - Power Distribution Module

Green	Power Distribution Module Status
ON	Normal operating condition.

Terminal Identification:
PD4UL/PD4ULCB/PD8UL/PD8ULCB - Power Distribution Module

Terminal Legend		Function/ Description
PD4UL/PD4ULCB	PD8UL/PD8ULCB	
1P to 4P	1P to 8P	Positive DC power outputs.
1N to 4N	1N to 8N	Negative DC power outputs.

Power Distribution Module(s):

Fig. 2A

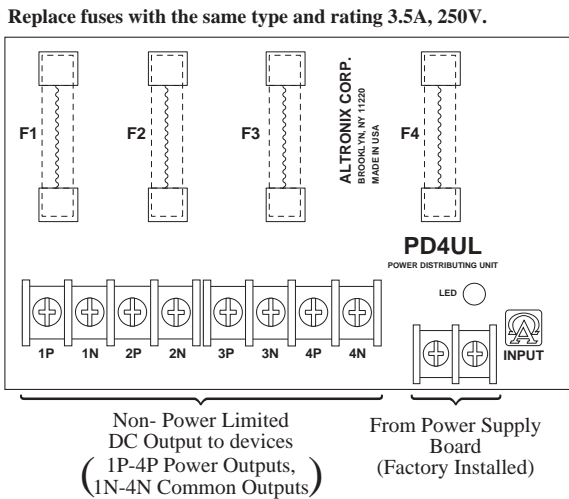

Fig. 2B

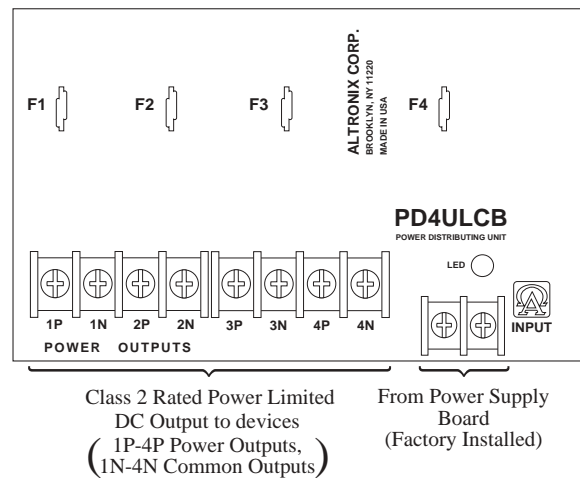

Fig. 3A

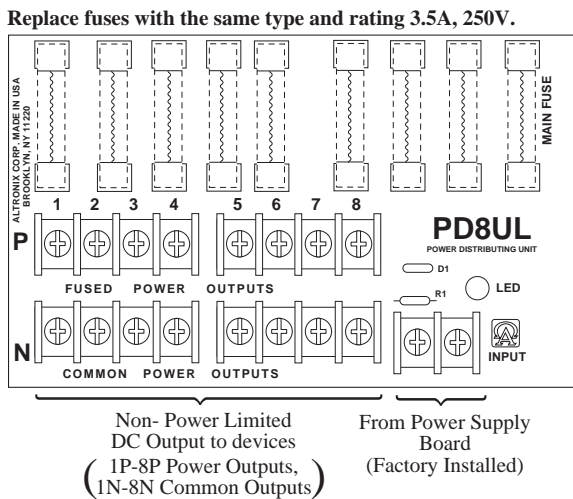
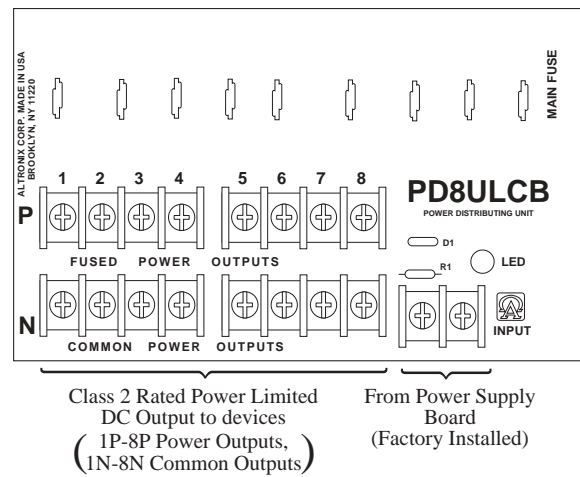

Fig. 3B



Wiring:

USE 14 AWG or larger for all power connections.

Note: Take care to keep power limited circuits separate from non-power limited wiring (115VAC, Battery).

Maintenance:

Unit should be tested at least once a year for the proper operation as follows:

Output Voltage Test: Under normal load conditions, the DC output voltage should be checked for proper voltage level.

Battery Test: Under normal load conditions check that the battery is fully charged, check specified voltage both at battery terminal and at the board terminals marked [- BAT +] to insure there is no break in the battery connection wires.

Note: Maximum charging current under discharges is 3.6 amp.

Note: Expected battery life is 5 years, however it is recommended changing batteries in 4 years or less if needed.

Battery size calculation worksheet.

A.	AL1024ULXPD series internal current consumption(standby)	_____	.05 A
B.	Load current consumption (standby)	_____	A
C.	Standby time required (hours)	_____	H
D.	Battery capacity required for standby (A+B)*C	_____	AH
E.	AL1024ULXPD series internal power consumption (Alarm)	_____	.05 A
F.	Load current consumption (Alarm)	_____	A
G.	Alarm duration (Hours, 15 Min=.2 Hour) (Alarm)	_____	H
H.	Battery capacity required for Alarm (E+F)*G	_____	AH
I.	Total calculated battery capacity D+H	_____	AH
J.	Battery capacity required I*1.8 (safety factor)	_____	AH

Note: AL1024ULX series power supply is designed to work with batteries up to 65AH. Please note, line [I] must not exceeds 36AH. You have to reduce either standby current consumption or standby time in order to comply with requirement.

To determine actual battery size please round line [J] to the nearest larger standard battery size (e.g. 3.5 AH = 4.0 AH).

Enclosure Dimensions:

15.5"H x 12"W x 4.5"D

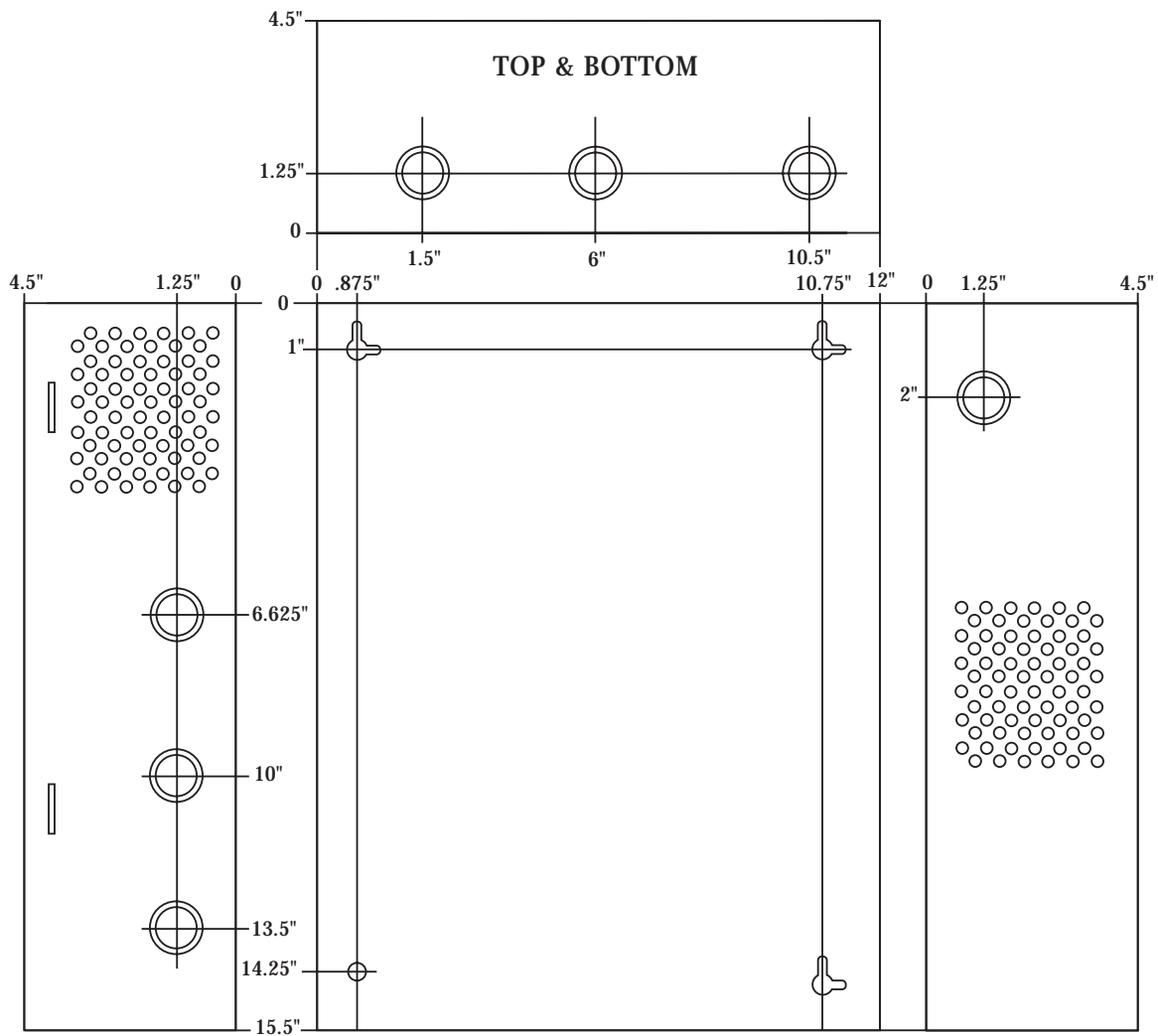

Altronix is not responsible for any typographical errors.

Altronix Corp.
140 58th Street, Brooklyn, New York 11220 USA, 718-567-8181, fax: 718-567-9056
web site: www.altronix.com, e-mail: info@altronix.com, Lifetime Warranty, Made in U.S.A.
IIAL1024ULX series K26C

