



## Fixed Color Cameras

**ADCA330CN**

**ADCA330CP**

**ADCA470CAFN**

**ADCA470CAFP**

Installation Manual

---

**INTRODUCTION**

These instructions cover the American Dynamics ADCA470 and ADCA330 series of color cameras. Read all of these instructions. Use them to install your camera and have them available for its lifetime. Note that not all cameras have all of the features described in this manual. Refer below for the features of the individual cameras.

All cameras are fitted with an auto-iris lens connector that is suitable for both direct drive (DC) and video drive auto-iris lenses. All cameras also have an adjustable back focus mechanism and accept C and CS lenses.

ADCA470 and ADCA330 series cameras feature:

- 1/3" CCD Sensor
- 470 TVL (ADCA470) or 330 TVL (ADCA330) resolution
- 0.7 Lux (ADCA470) or 0.5 Lux (ADCA330) low light sensitivity
- 24VAC/12V DC operation
- DSP Processing
- Automatic Gain Control (AGC)
- Backlight Compensation (BLC)
- Automatic Electronic Shutter (AES)
- Auto White Balance (AWB)
- Manual White Balance Adjust
- Line Lock with Phase Adjust (AC only)
- Auto-Detect DC and Video Auto-Iris Lens Feature

The ADCA470CAFN and ADCAC470CAFP high-resolution models offer an additional advanced feature set:

- Night-Saver™ Mode
- DVR-Saver™ Mode
- 7 Selectable Backlight Compensation (BLC) Zones

**⚠ WARNING**

Prior to installation and use of the product, the following warnings should be observed.

- Installation and servicing should be done only by qualified service personnel and conform to all local codes.
- Power camera only from a UL Listed, Class 2 isolated power supply.
- Do not remove covers as there is a risk of injury or death by electric shock.
- Do not touch the image surface of the sensor. If the sensor is accidentally touched, clean it only with isopropanol.
- Do not expose the camera sensor to very bright light over a long period of time as this may damage the CCD. The camera and lens setup must be correct to avoid continual overexposure to bright light. A lens with an automatic iris is recommended under these conditions.
- Before installing the lens, make sure that its back will not touch the CCD sensor or associated components when it is screwed into the camera.
- These cameras must only be used in clean, dry, dust-free environments. For outdoor use, an appropriate protective housing conforming to IP65 or UL50 or better must be used.
- Only operate your camera between the temperatures of -10°C and +50°C.

**REGULATORY NOTICES****ADCA330CN, ADCA330CP and ADCA470CAFP Models**

This equipment has been tested and found to comply with the limits of a Class B digital device, pursuant to part 15 of the FCC rules. These limits are designed to provide reasonable protection against harmful interference in a residential installation. This equipment generates, uses, and can radiate radio frequency energy and, if not installed and used in accordance with the instructions, may cause harmful interference to radio communications. However there is no guarantee that the interference will not occur in a particular installation. If this equipment does cause harmful interference to radio or television reception, which can be determined by turning the equipment off and on, the user is encouraged to try and correct the interference by one or more of the following measures:

- Reorient or relocate the receiving antenna.
- Increase the separation between the equipment and the receiver.
- Connect the equipment into an outlet on a circuit different from that to which the receiver is connected.
- Consult the dealer or an experienced radio/TV technician for help.

Modifications not expressly approved by the manufacturer could void the user's authority to operate the equipment under FCC rules.

This Class B digital apparatus complies with Canadian ICES-003.

Cet appareil numérique de la classe B est conforme à la norme NMB-003 du Canada.

**ADCA470CAFN Model**

This equipment has been tested and found to comply with the limits for a Class A digital device, pursuant to part 15 of the FCC Rules. These limits are designed to provide reasonable protection against harmful interference when the equipment is operated in a commercial environment. This equipment generates, uses, and can radiate radio frequency energy and, if not installed and used in accordance with the instruction manual, may cause harmful interference to radio communications. Operation of this equipment in a residential area is likely to cause harmful interference in which case the user will be required to correct the interference at his own expense.

Modifications not expressly approved by the manufacturer could void the user's authority to operate the equipment under FCC rules.

This Class A digital apparatus complies with Canadian ICES-003.

Cet appareil numérique de la classe A est conforme à la norme NMB-003 du Canada.

POWER SUPPLY CONNECTION

These cameras are designed to operate from a 12V DC or 24V AC power supply. Connections and polarity are indicated above the terminals on the rear panel. **The power supply must be of UL Listed, Class 2 isolated type.** The green power LED on the rear panel indicates when power is connected. Power consumption is less than 4.2 watts.

VIDEO CONNECTIONS

To obtain a video output, connect a video coaxial cable terminated with a 75Ω BNC connector to the BNC socket marked VIDEO OUT on the rear of the camera.

CAMERA LAYOUT

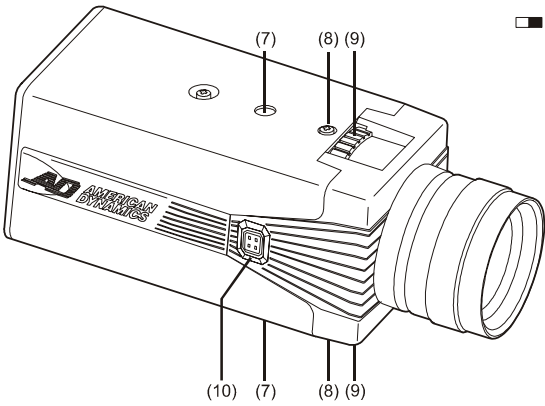
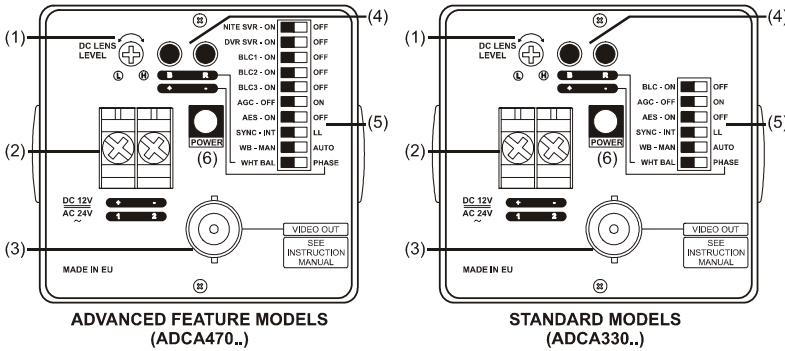

- 1. DC Lens Level adjustment
- 2. Low-voltage supply terminals
- 3. Composite video output
- 4. White Balance/Line-lock Phase adjustment buttons
- 5. Function switches (Camera default is all switches to the RIGHT)
- 6. Power LED
- 7. Mounting points
- 8. Back focus locking screws
- 9. Back focus adjustment
- 10. Auto-iris lens connector

---

**NIGHT-SAVER™ (NITE SVR) MODE**

---

Advanced feature models (ADCA470 series) are designed to provide a useable image even in extremely low light conditions. To activate Night-Saver™ mode, set the **NITE SVR** dip switch on the back panel to **ON**. The camera will operate in color where the scene illumination is bright and will automatically switch to monochrome where the scene illumination is low. Typically, the switchover occurs at approximately 2.0 lux.

To set the camera to operate in color at all times, set the **NITE SVR** dip switch to **OFF**.

---

**DVR-SAVER™ (DVR SVR) MODE**

---

Advanced feature models (ADCA470 series) have the DVR-SAVER™ mode. Digital video recorders use video compression (usually based upon the difference in subsequent frames) and the required storage capacity is therefore dependent upon the difference in scene content. Features such as AGC and sharpness enhancement etc., can generate signal noise which will be interpreted as a change in scene content, therefore increasing the amount of space required to store the video information. The DVR-SAVER™ mode feature may be used to reduce storage requirements when the camera is connected to a digital video recorder. Similarly, the DVR Saver can also be used to reduce bandwidth requirements when the camera is connected to a digital network via an encoder. When used with an American Dynamics' Intellex DVR, video file sizes can be decreased by up to 30%\*.

When the **DVR-SAVER™** dip switch is set to **ON**, the image may appear softer, though the difference is minimal once compressed in the DVR. There also may be a slight reduction in low light sensitivity. The default setting is **OFF**.

\*Results may vary based on lighting and scene content.

---

**BACKLIGHT COMPENSATION (BLC)**

---

The backlight compensation feature can be used to eliminate the effect of an area of strong background lighting in a scene. If a strong background light such as a window exists in a scene, the camera will try to compensate for it by reducing the overall exposure. This means that objects in front of the backlight may appear in silhouette.

BLC will only function with a manual iris lens when the AES facility is switched on. For direct drive (DC) and video drive lenses, BLC will still function even though the AES facility is switched off.

The functionality available differs between standard and advanced feature cameras.

**Standard Models (ADCA330 Series)**

On standard models, the Backlight Compensation feature compensates for back-lit scenes by enhancing objects in the centre of the scene which would previously have been in silhouette. Select **ON** or **OFF** using the **BLC** dip switch. Default is **OFF**.

**Advanced Feature Models (ADCA470 Series)**

On advanced feature models, it is possible to select areas of the scene which can be used to control the exposure. To facilitate this, seven pre-defined windows are provided. Use the three **BLC** dip switches to select one of the pre-defined windows, as shown in the diagram overleaf.

**BACKLIGHT COMPENSATION (BLC)**

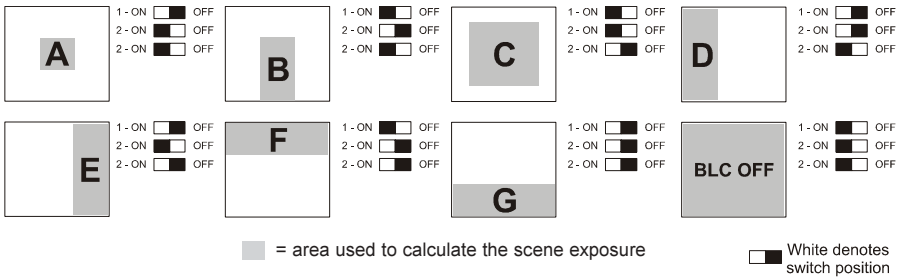

When BLC dip switches are adjusted, an overlay window is displayed on-screen showing the currently selected window. The overlay window will automatically disappear 5 seconds after the last dip switch setting is made. Any parts of the scene that are not covered by the BLC window will be ignored when determining the overall scene exposure.

**Back Light Compensation feature - Example**

People entering a building through a brightly lit doorway are to be monitored. Without backlight compensation, a person entering the building would be seen in silhouette because the relatively bright background would cause the camera to reduce its exposure.

By using the backlight compensation feature, it is possible to select a window around the area of interest, i.e. the doorway. Choosing window **B** will ensure that the camera exposure system only uses the central area of the scene to calculate the scene exposure. Therefore a person entering the building will be clearly displayed.



**BLC OFF**



**BLC ON**

**AUTOMATIC GAIN CONTROL (AGC)**

When switched on, the Automatic Gain Control feature will improve camera sensitivity when the level of scene illumination is low. As scene illumination level decreases, color information is reduced. For most applications the AGC feature should be switched on and is therefore the default setting. Select **ON** or **OFF** using the **AGC** dip switch.

---

**AUTOMATIC ELECTRONIC SHUTTER (AES)**

---

The Automatic Electronic Shutter (AES) feature compensates for excessive light levels by automatically adjusting the shutter speed of the camera. Select **ON** or **OFF** using the **AES** dip switch. The default setting is **OFF**.

When using video drive or direct drive (DC) auto-iris lenses, AES must be turned **OFF**. When using a fixed or manual iris lens, AES must be turned **ON**.

---

**SYNCHRONIZATION (SYNC) SELECTION (LL/INT)**

---

Use the **SYNC** dip switch to select the camera synchronization mode. When the camera is connected to an AC power supply, select linelock mode by setting the dip switch to **LL**. This locks the camera frame rate to the mains frequency so that cameras in a system are triggered at the same point on the AC cycle. Linelock should be disabled when using DC power or a noisy AC power supply. To do this, set the dip switch to **INT**.

If the **SYNC** dip switch is set to **LL**, manual phase adjustments can be performed using the two push buttons located on the rear of the camera. To activate these push buttons for manual phase adjustments, set the **WHT BAL/PHASE** dip switch to **PHASE**. The push buttons will then allow the user to advance or retard the line lock phase trigger point by  $\pm 180^\circ$  (360 $^\circ$  of adjustment). The factory default setting is the zero crossing point. To reset the trigger point to the factory default setting, press and hold both push buttons.

---

**WHITE BALANCE (WB)**

---

Two white balance modes can be selected using the **WB** dip switch. For the majority of applications, the **AUTO** setting will provide excellent color rendition and is the default setting. However, there may be instances where it is necessary to set the white balance manually. To do this, set the **WB** dip switch to **MAN**.

If the **WB** dip switch is set to **MAN**, adjustments to the red and blue components of the scene can be performed manually using the two push buttons located on the rear of the camera. To activate these push buttons for white balance adjustment, set the **WHT BAL/PHASE** dip switch to **WHT BAL**. To reset white balance to factory settings, press and hold both push buttons.

---

**LENS SELECTION**

---

Suitable lens types are C and CS mount in fixed iris, manual iris, video drive auto-iris or direct drive (DC) auto-iris versions. Compatible lens sizes are 1/3", 1/2", 2/3" and 1". Cameras are factory set for CS mount lenses. If using a C mount lens, rotate the back focus adjustment mechanism fully counterclockwise (when viewed from the front of the camera) before fitting the lens—see **Back Focus Adjustment**.

---

**BACK FOCUS ADJUSTMENT**

---

There are two adjustment points accessible from the top and bottom of the camera housing that are used to adjust the back focal length or picture focus. The range of adjustment allows both C and CS mount lenses to be used without the need for a spacer ring. To use the back focus mechanism:

1. Unlock the back focus mechanism using the back focus locking screws on the top and bottom of the camera.
2. Rotate the backfocus adjustment ring as required. When viewed from the front of the camera, clockwise adjustment moves the CCD sensor towards the back of the lens; counterclockwise adjustment moves the CCD sensor away from the back of the lens.
3. Lock the back focus mechanism.

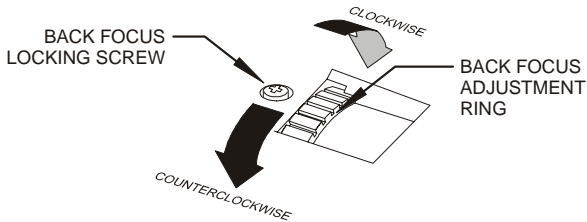

---

**INSTALLING FIXED IRIS LENSES**

---

1. Turn the back focus adjustment ring fully counterclockwise (when viewed from the front)—see **Back Focus Adjustment**.
2. Fit the lens to the camera.
3. If the lens has a focusing ring fitted, set it to infinity ( $\infty$ ) and then adjust the back focus—see **Back Focus Adjustment**.
4. Ensure the Automatic Electronic Shutter (AES) and Automatic Gain Control (AGC) features are both turned ON.

---

**INSTALLING MANUAL IRIS LENSES**

---

1. Turn the back focus adjustment ring fully counterclockwise (when viewed from the front)—see **Back Focus Adjustment**.
2. Fit the lens to the camera.
3. Turn the Automatic Electronic Shutter (AES) and Automatic Gain Control (AGC) features OFF.
4. If the lens has a focusing ring fitted, set it to infinity ( $\infty$ ) and then adjust the back focus—see **Back Focus Adjustment**.
5. With typical scene illumination, set the lens iris for the correct exposure. This can be achieved either visually, or by using an oscilloscope to set the output of the camera to 1V peak-peak.
6. Ensure the Automatic Electronic Shutter (AES) and Automatic Gain Control (AGC) features are both turned ON.

---

**AUTO LENS DETECT - INSTALLING AUTO IRIS LENSES**

---

These cameras automatically sense the type of auto-iris lens that is being used. This should result in less field installation errors due to incorrect switch settings. These cameras support either direct drive (DC) or video drive auto-iris lenses. The lenses are connected to the camera via a 4-pin square socket located on the side of the camera.

**Connecting Direct Drive (DC) Lenses**

1. Turn the back focus adjustment ring fully counterclockwise (when viewed from the front)—see **Back Focus Adjustment**.
2. Fit the lens to the camera and connect it according to the diagram below.

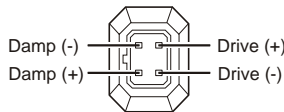

Direct Drive (DC) Lenses

**⚠ WARNING The maximum load for this type of lens must not exceed 25mA**

3. Turn the Automatic Electronic Shutter (AES) and Automatic Gain Control (AGC) features OFF.
4. If the lens has a focusing ring fitted, set it to infinity ( $\infty$ ) and then adjust the back focus—see **Back Focus Adjustment**.
5. With typical scene illumination, set the DC Lens Level adjustment potentiometer on the rear of the camera for the correct exposure. This can be achieved either visually, or by using an oscilloscope to set the output of the camera to 1V peak-peak.
6. Ensure Automatic Gain Control (AGC) is now turned ON. **AES must remain OFF.**

**Connecting Video Drive Lenses**

1. Turn the back focus adjustment ring fully counterclockwise (when viewed from the front)—see **Back Focus Adjustment**.
2. Fit the lens to the camera and connect it according to the diagram below.

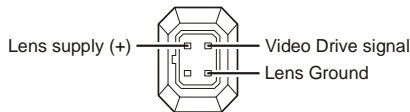

Video Drive Lenses

**⚠ WARNING The maximum load for this type of lens must not exceed 50mA**

3. Turn the Automatic Electronic Shutter (AES) and Automatic Gain Control (AGC) features OFF.
4. If the lens has a focusing ring fitted, set it to infinity ( $\infty$ ) and then adjust the back focus—see **Back Focus Adjustment**.
5. Refer to the lens instructions and adjust the lens for the optimum picture (video output level of 1V peak-to-peak).
6. Ensure Automatic Gain Control (AGC) is now turned ON. **AES must remain OFF.**

CAMERA MOUNTING

Mounting points are provided on the top and bottom of the camera and are used to mount the camera on a bracket or tripod. They are designed to accept standard photographic mounting bolts (1/4" 20 UNC). The mounting bracket must be capable of supporting the weight of the camera and its lens. In cases where the lens is substantially heavier than the camera, it is better to use the mounting point on the lens itself.

NOTE: Some installation codes dictate that the mounting bracket must be capable of supporting up to four times the combined weight of the camera and lens.

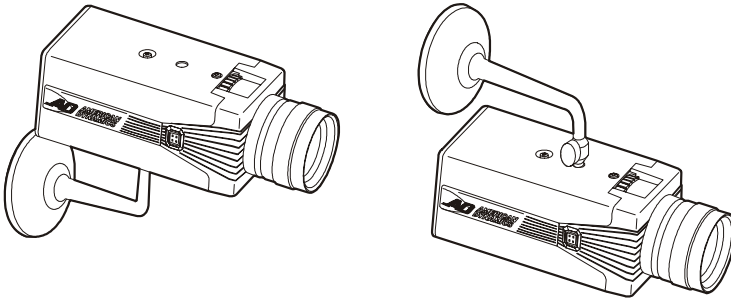

DIMENSIONS

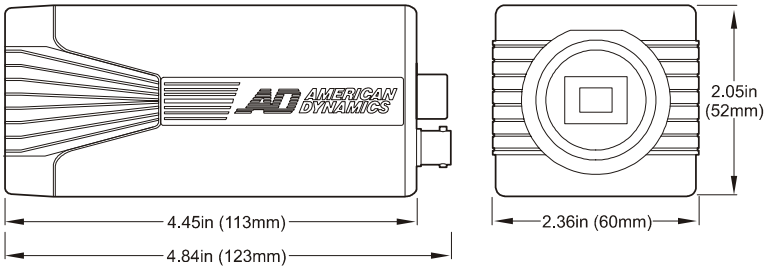

## SPECIFICATIONS

<b>Picture Elements</b>	ADCA330CN: 510(H) x 492(V) ADCA330CP: 500(H) x 582(V) ADCA470CAFN: 768(H) x 494(V) ADCA470CAFP: 752(H) x 582(V)
<b>Synchronization System</b>	AC line lock or internal oscillator
<b>Horizontal Resolution</b>	ADCA330: 330 TVL ADCA470: 470 TVL
<b>Minimum Illumination</b>	ADCA330: 0.5 lux F1.2 ADCA470: 0.7 lux F1.2
<b>Signal-to-Noise Ratio</b>	>50dB
<b>Vertical Phase</b>	±180° (360° adjustment range)
<b>Scanning System</b>	NTSC and PAL models available. 2:1 interlace
<b>Signal Processing</b>	Digital Signal Processing
<b>Video Output</b>	1V pk-pk, 75 ohms
<b>Auto Iris Lens Type</b>	Direct Drive (DC) or Video Drive using lens auto-sensing feature
<b>Automatic Gain Control</b>	Selectable on or off
<b>Gamma</b>	0.45 fixed
<b>White Balance</b>	Auto Tracing (Framed) 2500K to 9500K or Manual, with Red and Blue adjust using rear panel push buttons
<b>Backlight Compensation</b>	Selectable on or off on standard models, 7 user-selectable windows on advanced feature models
<b>Iris Control Range</b>	1/60 - 1/100,000 second on NTSC models, 1/50 - 1/100,000 on PAL models
<b>Power Requirements</b>	12V DC or 24V AC @ 60Hz on NTSC models 12V DC or 24V AC @ 50Hz on PAL models
<b>Power Consumption</b>	Less than 4.2 watts
<b>Lens Mount</b>	C/CS mount with adjustable back focus
<b>Camera Mount</b>	2 x 1/4" 20 UNC threaded mounting point (top and bottom)
<b>Operating Temperature</b>	-10°C to 50°C (14°F to 122°F)
<b>Storage Temperature</b>	-20°C to 60°C (-4°F to 140°F)
<b>Weight (without lens)</b>	0.77 lbs (0.35 Kg)

Please visit our website for more information  
**[www.americandynamics.net](http://www.americandynamics.net)**

© 2003 American Dynamics

Product specifications subject to change without notice  
Certain product names mentioned herein may be trade names  
and/or registered trademarks of other companies

HB-ADCACAM-2  
8200-0206-14